

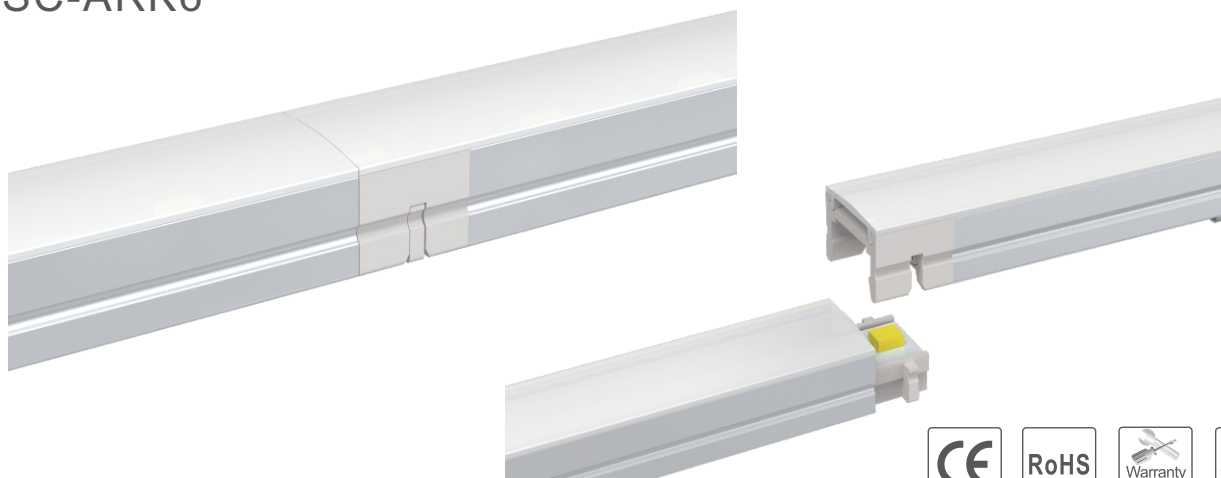

2835 Seamless Lightbar

SC-ARK6



Features:

1. Seamless joint strip
2. High lighting effect, 2835 high brightness LEDs
3. Small size, 5 m can be connected in maximum
4. Magnetic or mount holder, convenient to install
5. Suitable for cabinet, exhibition frame, goods shelf, wardrobe, bookcase and other lighting
6. 3 years warranty, CE, Rohs

Technical parameters :

Model	Colour	Lumen (lm)	LED Type	LED Qty.	Length (mm)	DC Voltage (V)	Rated Watt (w)	Rated Current (A)	Beam angle
SC-ARK6-W-512-12V	White	716	2835	30	512	12	7.2	0.6	120°
SC-ARK6-NW-512-12V	Neutral White	671							
SC-ARK6-WW-512-12V	Warm White	605							

Accessories:

Name	mount holder	screw	end cap	connection wire	middle connection wire *(optional)
Drawing					
Qty.	2PCS	2PCS	1PCS	1PCS	/



Dimension Drawings:

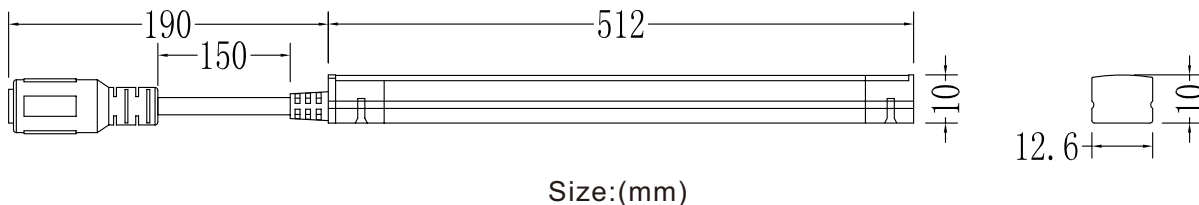

Connecting&Installation Diagram:

LED Installation Steps:

I. Holder installation

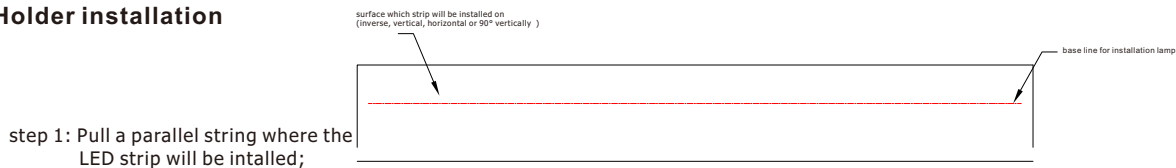

As figure 1

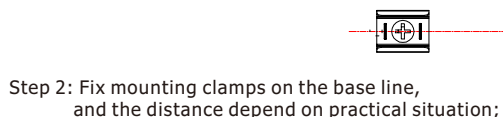

As figure 2



As figure 3

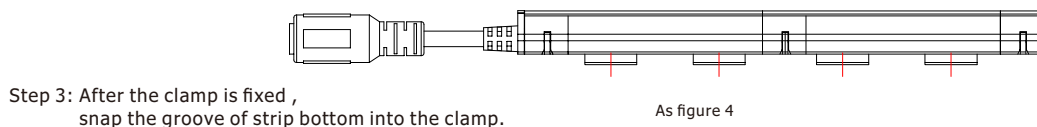

As figure 4

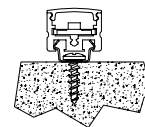

As figure 5

II. Magnet adsorption installation

There is magnet in the LED strip bottom; can be directly adsorbed on the surface of iron products, quick to install.

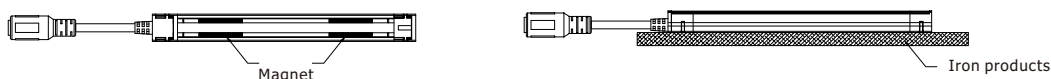

First confirm the installation position of LED strip, after one has been installed, joint another. Connecting before installation is not permitted. 5m can be connected in maximum.



Strip connection step:

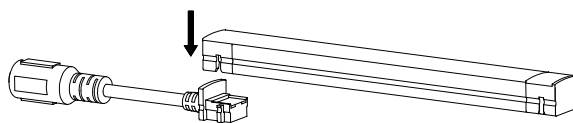

1. Snap the front plug into wire socket from top-down, when connect another strip, the end cap need be removed first;

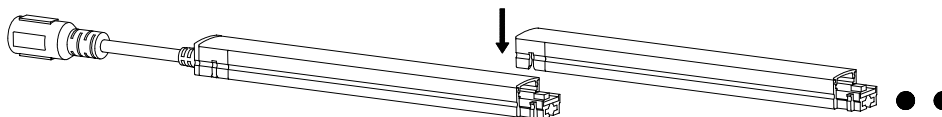

2. Snap the front plug of the second strip into the first strip, then connected in turn;

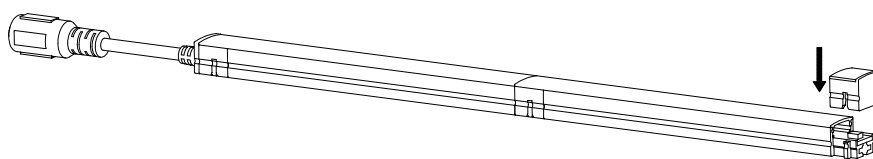

3. When connect to the last strip, cover the components of end cap and connected;

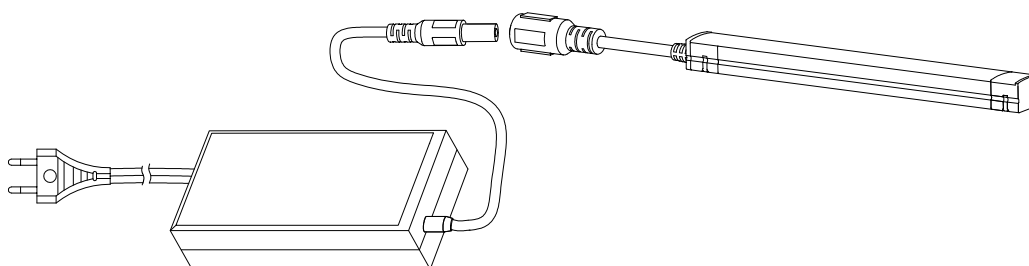

4. Finally connected to power supply, installation finish.

Packing instruction:

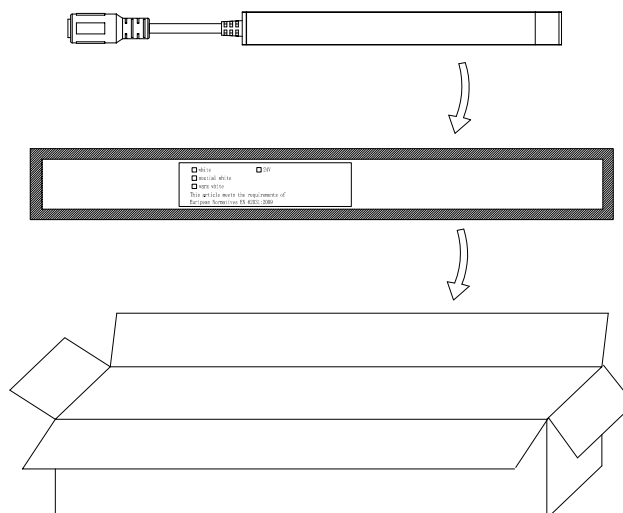

Put the LED strip into electrostatic bag, then put the electrostatic bag into the carton.



Installation requirement:

1. Please read the product specification carefully, make sure operating environment conform to condition in specification, then it can be used;
2. Correct electrical polarity needs to be observed. Wrong polarity may destroy the strip;
3. Confirm input voltage before using and power off;
4. Pay attention to the standard ESD precautions when installing the strip;
5. The length of serial connection can't exceed 5m, and the LED strip can't exceed 10 pieces.